

# STAR LIGHTING PRODUCTS

## INSTALLATION AND INSTRUCTION MANUAL

# STARBAR



**WARNING!**

These lightbars contain one or more of the following light sources: Strobe Lights, Halogen Lamps, and/or High Intensity LED Lamps. DO NOT stare directly into any of these light sources as temporary blindness and/or permanent eye damage may occur.

***Please Note:*** These instructions are provided as a general guideline only. Specific mounting, wiring, and/or weather-sealing may be necessary and are the sole responsibility of the installer. Star Headlight & Lantern Co., Inc. assumes no responsibility for the integrity of the installation for this or any of its products.

## Table of Contents

<b>WARNINGS</b> .....	<b>i</b>
<b>QUICK-INSTALL WIRING GUIDE</b> .....	<b>1</b>
<b>MOUNTING INSTRUCTIONS</b> .....	<b>2</b>
(For Mounting see <i>Mounting Bracket</i> Manual)	
<b>WIRING INSTRUCTIONS</b> .....	<b>2-9</b>
Wire Harness Replacement.....	2-3
Electrical Connections.....	4
Remote Power Supply Connections for Linear Strobe Heads.....	5-9
<b>STROBE PATTERN PROGRAMMING</b> .....	<b>9</b>
<b>LED PATTERN PROGRAMMING</b> .....	<b>10-11</b>
<b>TROUBLESHOOTING</b> .....	<b>12-15</b>
<b>PARTS</b> .....	<b>16</b>
<b>SWITCHES</b> .....	<b>17</b>
<b>WARRANTY</b> .....	<b>18</b>
<b>SERVICE</b> .....	<b>18</b>

### NOTICE

Due to continuous product improvements, we must reserve the right to change any specifications and information, contained in this manual at any time without notice. Star Headlight & Lantern Co., Inc. makes no warranty of any kind with regard to this manual, including, but not limited to, the implied warranties of merchantability and fitness for a particular purpose. Star Headlight & Lantern Co., Inc. shall not be liable for errors contained herein or for incidental or consequential damages in connection with the furnishing, performance, or use of this manual.



*It is the sole responsibility of the owner to ensure the lightbar is mounted securely. Check your light every time you enter the vehicle to ensure that it is mounted securely. The manufacturer assumes no responsibility for the secure mounting of this light.*



*When mounting your lightbar, please be sure to keep any radio frequency sensitive equipment at least 20" from the bar and power cable(s). This is especially critical in lightbars utilizing strobes. Our strobe power supplies have been designed to limit RFI emissions, but certain very sensitive equipment may still be affected. Symptoms may include, but are not limited to, sporadic operation and degraded performance. Star Headlight & Lantern Co., Inc. cannot assume any responsibility for any radio frequency induced malfunction or damage to any radios, sirens, lightbars, or any other equipment mounted within 20" of a strobe lightbar. Any antennae mounted in the proximity of the lightbar may cause your radio to suffer the aforementioned results.*

# QUICK-INSTALL WIRING GUIDE

All lightbars are shipped with a Wire Harness Assembly Checklist that is unique to your bar and will define what each wire controls. You can also use the chart below for general reference.

**Please note:** Depending upon the components in your lightbar, the wire colors used in your harness may differ slightly from the chart below.

## Wire Harness Usage Chart

LIGHT(S)	WIRE COLOR	Minimum AWG
<i>Connect to Negative Side of Battery</i>		
-12 VDC /Ground/Neutral	Black	10
<i>Connect to +12VDC</i>		
Rotating Halogen Lights	Orange	14
Secondary Rotator	Orange w/Black Stripe	14
360° Strobe, 360° Halo, or Strobe Power Pack*	Red	14
Front Strobe Heads On/Off (4-Head Packs Only)*	White w/Green Stripe	22
Rear Strobe Heads On/Off (4-Head Packs Only)*	Black w/Green Stripe	22
Pattern Select (Strobe and/or LED)‡	Red w/Green Stripe	22
Alternate Strobe Pack PWR	Red w/Black Stripe	14
LED Flasher Power (LDF369 or LDF398)	Orange w/Red Stripe	16
LED High/Low Control	Purple	18
Front Take-Down/Work Lights	Green w/Yellow Stripe	14
Rear Floods/Work Lights	White w/Orange Stripe	14
Front Alternating Flashers	White w/Brown Stripe	16
Rear Alternating Flashers	White	16
Driver's Side Alley Light	Blue	16
Passenger Side Alley Light	Gray	16
Left Turn Signal	Yellow	16
Right Turn Signal	Green	16
Tail Lights & ID Marker Lights	Brown	18
Intersection Clearing Lights	White w/Blue Stripe	18
Alternate Power	Red w/White Stripe	14
Traffic Director	†	†

\* See Remote Strobe Power Supply Connection section on pages 5-8

‡ See Pattern Programming section on page 9-11

† Separate Bundled 9-Conductor Cable

**‡ Please note:** If you have a lightbar with a strobe pack or LED flasher, the **Red w/Green Stripe** wire is only used when programming the flash pattern. **This wire MUST NOT be connected to continuous +12VDC!!!** Once the pattern has been selected, tape the end of this wire off. (See page 10)

Please find to the right a sample of the terminal block, showing the correct wire colors from a lightbar using the 271STROBE cable.

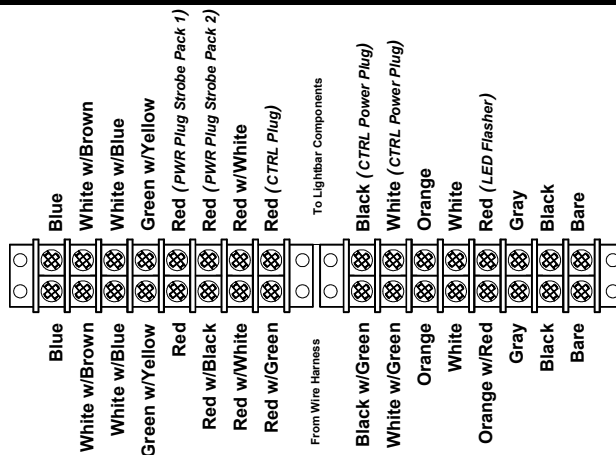

## Mounting Instructions

Please review the separate Mounting Bracket manual that is also enclosed with your bar for mounting instructions.

## Wiring Instructions

**PLEASE NOTE:** If you are using the existing 15-foot cable supplied with the lightbar, you may skip to the Electrical Connections section on page 4.

### Wire Harness Replacement

**If the wire supplied is too short**, Star recommends direct wiring to the terminal block on the inside of the lightbar, rather than making connections to the end of the wire that is supplied. This lightbar is designed so that no wire connectors are needed and only a few common tools are necessary in order to do this. Direct wiring allows the wire connections to the lightbar to be made in a clean and dry environment, avoiding any problems that may arise due to weathering on external connections. There is also an increase in voltage loss with the addition of each connection. Wiring directly inside the lightbar reduces the number of connections. However, making connections to the wires already provided is an acceptable alternative, as long as these connections are good electrical connections and are resistant from weathering effects. For direct wiring into the lightbar, follow the instructions listed below.

1. Use the Wire Usage Table shown on page 1 to determine how many wires you will need to run.
2. After identifying the necessary wires, select appropriate wire sizes and colors.
3. Locate the end of the lightbar that has the external wires entering the base of the lightbar. The black terminal block(s), which you will be making your wire terminations to, should also be located at this same end.
4. Remove the dome lens at this end of the lightbar:

**Step A :** Gently press down on the end of the dome and remove the two screws holding the dome to the endcap.

**Step B :** Loosen the two 5" screws holding the dome to the base, through the bulkhead.

**Step C :** Lift the dome off of the base exposing the interior components.

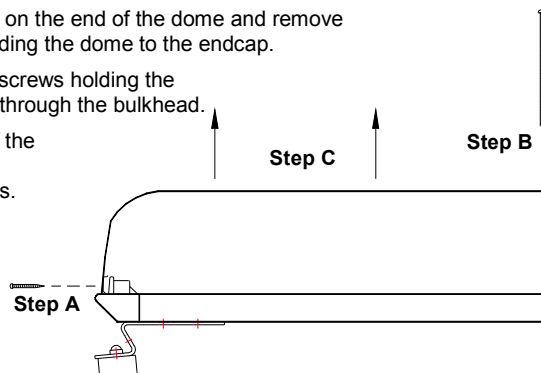

(Direct Wiring Guide CONT'D)

5. All of the wires coming from outside of the lightbar are terminated on the same side of the terminal block and the wires leading to the internal components terminate on the opposite side of the terminal block. Loosen the screws on the terminal block and remove **only those wires that exit the lightbar through the hole in the base**. There may be "dead" wires from the harness connected to the terminal block inside your lightbar, but there will be no wires connected to the terminal across from them. These are extra wires in the harness that are not used. Replacing these wires in your new harness is not necessary.

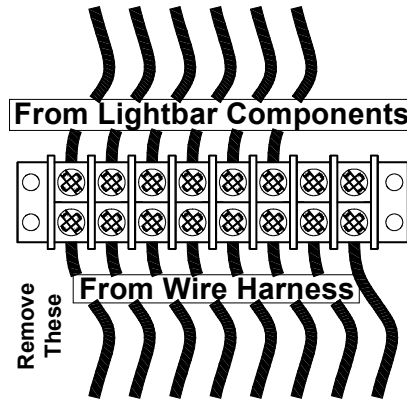

6. Run the new external wires up through the wire bushing into the base and into the terminal block(s). The function of each of the colored wires in the original wiring harness is listed in the *Wire Harness Usage Table* on page 1. There should also be a label next to the terminal block indicating which color wire should be connected to each terminal.
7. Strip each wire 1/4". Connect the external wires to the proper poles of the terminal block by inserting the stripped portion of the wire under the rising clamp screw and tightening down the screw. No wire terminals are needed for connecting wires to this terminal block.

**Be sure to check that no strands of wire are loose and shorting to the adjacent terminal or to the base of the lightbar.**

The correct wire size and color listed in the table on page 1 corresponds directly with the wiring of the lightbar. All switches used should be rated for at least 125% of their rated load.

8. When all work is completed, reverse Steps A-C in #4 to reinstall the dome, taking care that the gasket is properly aligned.
9. Once your new wire harness has been connected to the lightbar, you may continue to the *Electrical Connections* section.

## Electrical Connections

**All standard lightbar models are designed for 12VDC negative ground vehicles only. Reverse polarity will cause serious damage to the lightbar and/or vehicle. Contact the automotive dealer if there are any doubts about the polarity of your vehicle.**



### RF INTERFERENCE

**Please take the following steps to help eliminate any Radio Frequency Interference (RFI) with your two-way radio.**

- **DO NOT** run the power wire for the lightbar along same path as any antenna wires.
- **DO NOT** run the power wire for the lightbar along same path as any radio power wires.
- **DO NOT** tap power for the lightbar off of the radio power wires.
- **DO NOT** mount the lightbar within 20" of any antennae. Sometimes mounting the lightbar or antenna over by just one foot can make a large difference in the interference.
- Ensure the black wire from the lightbar has a good connection to the **negative side of the battery.**

Use the *Wire Harness Usage Table* on page 1 to identify the wire colors and connect the appropriate wires to your switches supplying +12VDC.

- For all standard lightbars, 15 feet of cable is supplied with the bar. All wires are color coded and sized at the correct gauge. If this length is not sufficient, it is recommended that the wire harness be completely replaced with the only connections to be made directly at the terminal block inside the lightbar. This will reduce the number of wire connections and help prevent any weathering problems on these connections. Refer to the *Wire Harness Replacement* section on pages 2-3 for further instructions on this.
- **CAUTION: All wires and switches should be rated for at least 125% of their maximum current load.** In addition, all wires connected to the positive terminal of the battery should be fused at the battery for 125% of their rated load. The load can be calculated by adding all lamp wattages and dividing by 13. (Load <Amps> = Total Watts / 13 volts) **Do not use** 1/4" diameter glass fuses, as they are not suitable for continuous duty above 20 amps. A table of recommended wire colors and wire sizes is provided on page 1. If you are unsure of the current draw, please contact our Customer Service Department.
- **TESTING THE LIGHTBAR BEFORE IT IS PROPERLY FUSED & INSTALLED WILL VOID THE WARRANTY!!**
- The black ground wire should be connected to the negative terminal of your vehicle's battery. This wire should be at least #10 AWG wire and be as short as possible in order to minimize the voltage loss in this wire and reduce any chance of overheating.
- The *Wire Harness Usage Table* on page 1 lists the different wire colors and lights controlled by those wires. Your harness may contain unused wires. The "dead" wires in the harness will be connected to the terminal block inside your lightbar, but there will be no wires connected to the terminal across from them. These "dead" wires can be used for additional components that may be added at some point in the future, or they may be used to separately switch components that are currently wired together.
- Since many of the lightbars we build have custom components, occasionally wire colors may slightly vary. If you are unsure of the function of a particular wire, you may test the function by grounding the black wire and applying +12VDC to the wire in question. Be sure to use a 20-amp fuse when testing.

## Remote Strobe Power Supply Connections For Linear Strobe Heads

If your lightbar DOES NOT contain linear strobe heads, you can skip to page 10.

If your lightbar contains linear strobe heads, follow the instructions on pages 5-9 for proper wiring of the strobe power supply. **Please note that any additional lights in your lightbar must also be connected to +12VDC through a switch.** This section only discusses the proper wiring of the strobe power supplies. For each strobe head configuration, you will be shown two ways to wire the lightbar:

1. All strobe heads turn On and Off together
2. Separate activation of Front and Rear facing strobe heads

### Lightbars with Two or Four Linear Strobe Heads

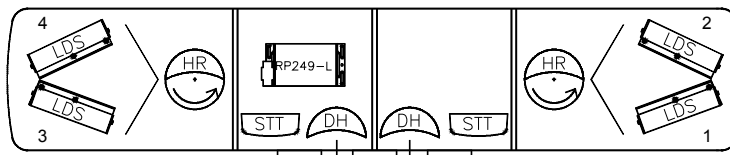

(Pictured above is one example of a bar with four linear strobe heads)

Four wires in your cable harness control the strobe power supply and the strobe heads connected to it. The functions of those wires are as follows:

#### Connect to +12VDC

**Red** - Power to the strobe power supply

**White w/Green Stripe** - On/Off control for Front Linear Strobe Heads

**Black w/Green Stripe** - On/Off control for Rear Linear Strobe Heads

#### Touch and release to +12VDC

**Red w/Green Stripe** - Pattern Select

### Activating All Strobe Heads Together

(MOST APPLICATIONS)

To turn on all four heads connected to the power supply together, connect the Red, White w/ Green Stripe, and Black w/Green Stripe wires together through your switch. When the switch is thrown, all of your strobes will flash. (#1 & #4 will alternate with #2 & #3)

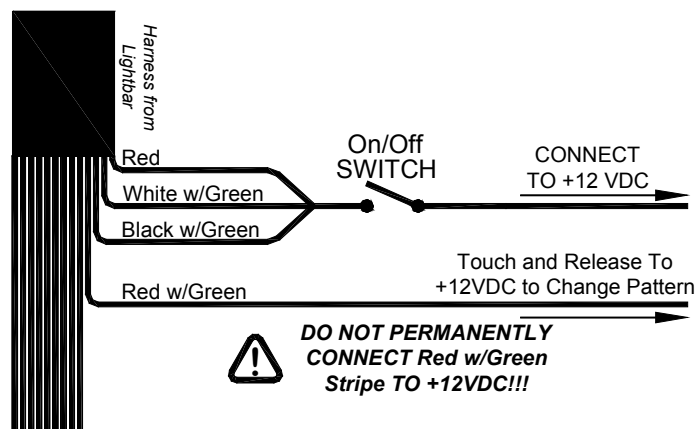

Proceed to the Pattern Selection section on page 10 to program the flash pattern of your strobe pack.

**Lightbars with Two or Four Linear Strobe Heads (cont'd)**

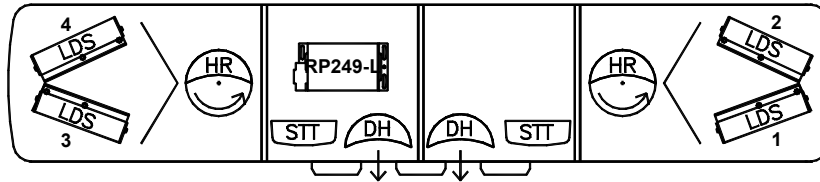

(Pictured above is one example of a bar with four linear strobe heads)

**Activating the Front and Rear Strobes Separately**

If you would like the ability to switch the Front Strobes On and Off separate from the Rear Strobes, connect the White w/Green Stripe wire to the switch that will activate your Front Strobes, and connect the Black w/Green Stripe wire to the switch that will activate your Rear Strobes.

The Red wire must be connected to constant +12VDC.

**Please Note:** When the red wire is connected to +12VDC the pack will draw a small current (50 mA). If your vehicle will be sitting for extended periods of time (i.e. more than a few days), it is recommended this wire be routed through a switch.

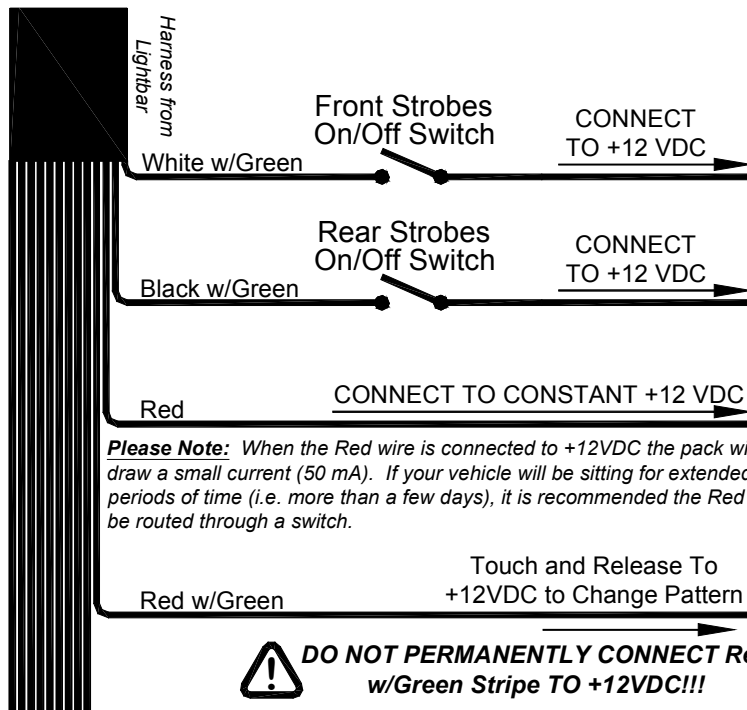

**Please Note:** When the Red wire is connected to +12VDC the pack will draw a small current (50 mA). If your vehicle will be sitting for extended periods of time (i.e. more than a few days), it is recommended the Red wire be routed through a switch.

**Note:** If you have power to both White w/Green and Black w/Green, #1 & #4 will flash together alternating with #2 & #3. For two outlet packs, the two heads will alternate.

Proceed to the Pattern Selection section on page 10 to program the flash pattern of your strobe pack.



### Lightbars with Eight Linear Strobe Heads

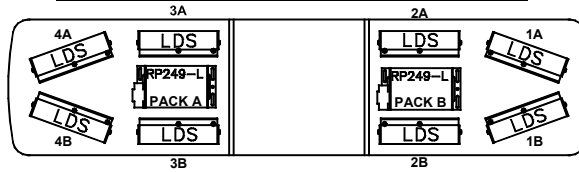

(Pictured above is one example of a bar with 8 linear strobe heads)

Three wires in your cable harness control the strobe power supplies and the strobe heads connected to them. The functions of those wires are as follows:

**Connect to +12VDC**

**Red** - Front Linear Strobe Heads On/Off

**Red w/Black Stripe** - Rear Linear Strobe Heads On/Off

**Touch and release to +12VDC**

**Red w/Green Stripe** - Pattern Select

**Note:** Heads #1 & #4 will flash together alternating with #2 & #3.

**Activating All Strobe Heads Together**

(MOST APPLICATIONS)

To turn on all eight heads connected to both power supplies together, connect the Red and Red w/Black Stripe wires together through your On/Off switch. When the switch is thrown, all of your strobes will flash. (#1 & #4 will alternate with #2 & #3)

Proceed to the Pattern Selection section on page 10 to program the flash pattern of your strobe packs.

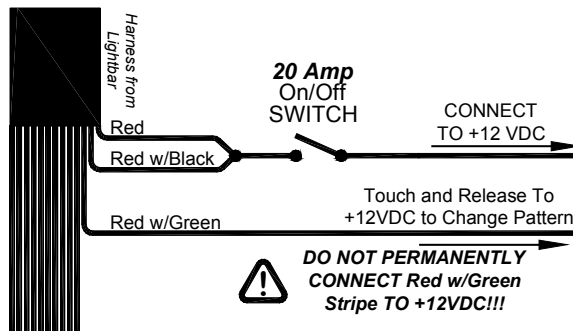

**Activating Front and Rear Strobes Separately**

To turn on your front strobe separately from your rear strobes, connect the Red and Red w/Black Stripe wires through two separate switches. When one switch is thrown, only the front strobes will flash. (#1 & #4 will alternate with #2 & #3). When the other switch is thrown the rear strobes will flash.

Proceed to the Pattern Selection section on page 10 to program the flash pattern of your strobe pack.

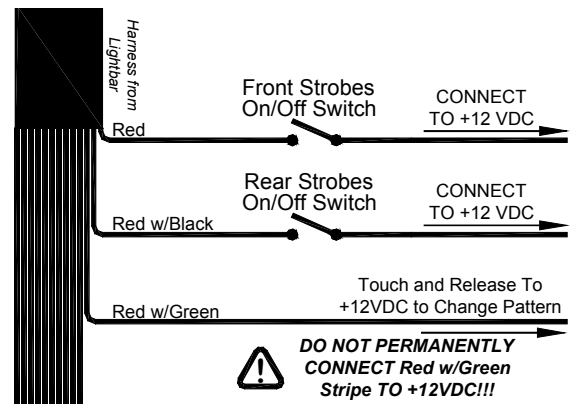

## Lightbars with Ten or Twelve Linear Strobe Heads

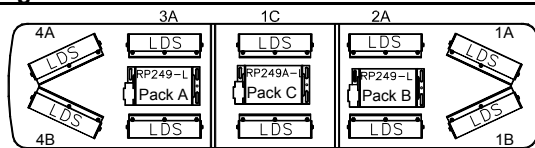

(Pictured above is one example of a bar with 10 linear strobe heads)

Four wires in your cable harness control the strobe power supplies and the strobe heads connected to them. The functions of those wires are as follows:

### Connect to +12VDC

**Red** - Front Linear Strobe Heads On/Off

**Red w/Black Stripe** - Rear Linear Strobe Heads On/Off

**Red w/White Stripe** - Constant Power (+12 VDC) for Center Strobe Pack

### Touch and release to +12VDC

**Red w/Green Stripe** - Pattern Select

### Activating Front and Rear Strobes Separately

(RECOMMENDED FOR MOST APPLICATIONS)

To turn on your front strobe heads separately from your rear strobes, connect the Red w/White Stripe wire to constant +12VDC.

**Please Note:** When the Red w/White Stripe wire is connected to +12VDC the pack will draw a small current (50 mA). If your vehicle will be sitting for extended periods of time (i.e. more than a few days), it is recommended the Red w/White Stripe wire be routed through a switch.

Then connect the Red and Red w/Black Stripe wires through two separate switches. When one switch is thrown, only the front strobes will flash. (#1 & #4 will alternate with #2 & #3). When the other switch is thrown the rear strobes will flash.

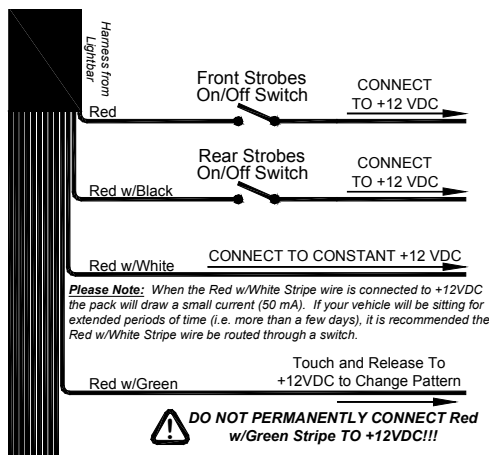

Proceed to the Pattern Selection section on page 10 to program the flash pattern of your strobe pack.

### Activating All Strobe Heads Together

To turn on all of the strobe heads in your lightbar together, connect the Red, Red w/Black Stripe, and Red w/White Stripe wires together through your switch. When the switch is thrown, all of your strobes will flash. (#1 & #4 will alternate with #2 & #3).

**Please note:** For this application, your switch **MUST** be able to handle 30 amps. This configuration is usually not recommended, since most switches are not capable of handling such a heavy load.

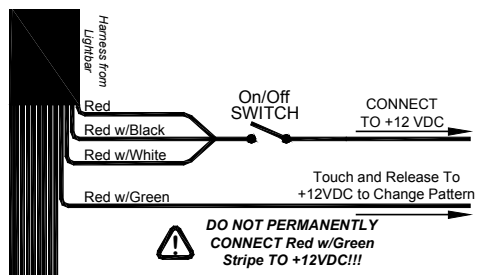

Proceed to the Pattern Selection section on the page 10 to program the flash pattern of your strobe packs.

*(Remote Strobe Power Supply Connections For Linear Strobe Heads cont'd)*

#### **Automatic Power Up Head Check**

Your new power pack comes with a safety feature which checks for proper operation of each individual strobe head each time you turn on the strobe pack. This feature works by quickly flashing each head once separately and determining if any of the heads did not flash. If two heads normally flash together and one should fail and does not flash during the start up test, the strobe pack will automatically reduce the output power to that particular side so that the "other" remaining head(s) isn't over powered. The power to that side will be cut in half until the strobe pack is turned off and on again.

The strobe pack will check all of the heads each time the pack is turned on EVEN if the head select feature is being used and only two heads are to be activated. After checking all of the heads, the pack will begin flashing normally. It takes approximately 0.250 sec. to check all of the heads.

**Note:** *If you replace the non-working head, it is necessary to cycle power to the pack before that head and the one that flashes with it will start flashing again at full power.*

## **Strobe Pattern Programming**

#### **Linear Strobe Pattern Selection**

1. Activate the strobe heads (if they are in your bar) by applying power to the appropriate wire (s) (usually Red wire).
2. Briefly touch the Red w/Green stripe wire to +12VDC and release it, repeating this to scroll through the patterns listed below. The cycle will repeat itself after the last pattern.

**Five-Flash → Pseudo-Random → Singleflash → Doubleflash → Quadflash**

3. Once you find the pattern you wish to select, leave the Pattern Select terminal disconnected and turn the flasher off. This will store the selected pattern into the memory.



**Please note:** *If you have a lightbar with a strobe pack, the Red w/ Green Stripe wire is only used when programming the strobe pack flash pattern. This wire MUST NOT be connected to continuous +12VDC. Once the pattern has been selected, tape the end of this wire off.*

## **LED Pattern Programming**

**LEDs in your lightbar are programmed using the Red w/Green stripe wire. If you have LEDs controlled by an external flasher (LDF369 or LDF398), the pattern will be set by touching the Red w/Green wire to +12VDC. If you have Halo 360° LEDs, you will set the pattern by touching the Red w/Green wire to ground.**

### **LED Pattern Selection for Remote LED Flashers**

1. Power up the LED heads you wish to program by applying power to the appropriate wire (s) (usually Orange w/Red Stripe for remote flashers).
2. Briefly touch the Red w/Green stripe wire to +12VDC and release it, repeating this to scroll through the patterns listed below. The cycle will repeat itself after the last pattern.
3. Once you find the pattern you wish to select, leave the Pattern Select wire disconnected and turn the LEDs off. This will store the selected pattern.

### **8-Terminal LDF369 Flash Patterns (touch Red w/Green to +12VDC)**

- |  |   |
|--|---|
| 1. Slow Warn                                   | 18. Comet 1                             |
| 2. Alt. Doubleflash, Flicker                   | 19. Alt Long Singleflash (Medium Warn)  |
| 3. All Double, Alt. Pre-Pop Triple, Slow Warn  | 20. Alt. Short - Alt. Long              |
| 4. Alternating Doubleflash, Non-Synch          | 21. Slow Warn, Alt. Tripleflash         |
| 5. Alt. Triple, Alt. Pre-Pop Triple, Flicker * | 22. Slow Warn, Super Fast Warn          |
| 6. Alt. Quad, Flicker, Alt. Double, Flicker    | 23. All Doubleflash, Alt. Doubleflash   |
| 7. Alt. Pre-Pop Quint, Alt. Quint, Flicker     | 24. All Double, Alt. Double, Flicker    |
| 8. All Tripleflash                             | 25. Fast Warn                           |
| 9. Alt. Quadflash w/Post Pop                   | 26. Superfast Warn                      |
| 10. All Quadflash w/Post Pop                   | 27. Warn Fade                           |
| 11. Alt. Quintflash                            | 28. Pre-Pop Warn                        |
| 12. One Side Steady/Other Side Singleflash †   | 29. All Singleflash                     |
| 13. Alt. Pre-Pop Quintflash                    | 30. Alt. Tripleflash                    |
| 14. All Flicker                                | 31. All Quintflash                      |
| 15. Alt. PSU Flicker                           | 32. One Side Pop, Other Side Rapid Fire |
| 16. One Side Steady/Other Side Short-Long †    | 33. Comet 2                             |
| 17. One Side Rapid Fire, Other Side Pop        | 34. Delta Omega                         |
|  | 35. Cycle All Patterns                  |

\* = Default Pattern

† = California Title 13 Approved w/Red Steady/Blue Flashing

**NOTE:** If at any time you would like to reset the pattern to the factory default (Pattern 28), simply connect the Pattern Select wire to +12VDC for five seconds, then release it, and the default pattern will be restored.

### **20-Terminal LDF398 Flash Patterns (touch Red w/Green to +12VDC)**

- |   |  |
|---|--|
| 1 Pursuit Mode (Default)                        | 16 In/Out Quint (1,2,9,10 vs 3-8)                    |
| 2 Alternating Slow Single (1-5 vs 6-10)         | 17 In/Out Single (1,2,3,8,9,10 vs 4-7)               |
| 3 Alternate Pursuit Mode                        | 18 In/Out Triple (1,2,3,8,9,10 vs 4-7)               |
| 4 Alternating Quad Flash (1-5 vs 6-10)          | 19 In/Out Quint (1,2,3,8,9,10 vs 4-7)                |
| 5 Alternating Triple (1,2,6,7,8 vs 3,4,5,9,10)  | 20 1-5 Steady; 6-10 Single Flash                     |
| 6 Alternating Quint (1,2,6,7,8 vs 3,4,5,9,10)   | 21 1-5 Steady; 6-10 Slow Single Flash                |
| 7 Simultaneous Slow Single (All Modules)        | 22 6-10 Steady; 1-5 Single Flash                     |
| 8 Simultaneous Fast Single (All Modules)        | 23 6-10 Steady; 1-5 Slow Single Flash                |
| 9 Simultaneous Triple Flash (All Modules)       | 24 Sequential Back And Forth                         |
| 10 Simultaneous Quad Flash (All Modules)        | 25 Sequential In/Out                                 |
| 11 Simultaneous Quint Flash (All Modules)       | 26 Burst All w/ Alternating Burst                    |
| 12 Simultaneous Fast Triple Flash (All Modules) | 27 Alternating Burst w/ Sim. Double Then Quint       |
| 13 Simultaneous Fast Quint Flash (All Modules)  | 28 Simultaneous Burst w/ Alt. Double Then Quint      |
| 14 In/Out Single (1,2,9,10 vs 3-8)              | 29 Hyper-Random                                      |
| 15 In/Out Triple (1,2,9,10 vs 3-8)              | 30 Demo (Cycle Through Patterns 1-4,6-9,13-20,25-29) |

**Please Note:** At any time during the programming sequence, you can reset the flash pattern back to the default mode (Pattern 1 – Pursuit) by holding the red w/green Pattern Select wire to +12VDC for 5 seconds, then releasing it.

(LED Pattern Programming cont'd)

**LED Pattern Selection for 360° Halo Heads (touch Red w/Green to ground)**

1. Power up the LED heads..
2. Touch and release the Red w/Green stripe wire to ground to scroll through the patterns listed below. The cycle will repeat itself after the last pattern.
3. Once you find the pattern you wish to select, leave the Pattern Select wire disconnected and turn the LEDs off.

**360° Halo™ Flash Patterns**  
**(touch Red w/Green to ground)**

Flash Pattern #	Pattern Type	Pattern Description	CPS	Shortcuts (Hold Red w/Green wire to ground for:)
1	K	Flicker †	1	<b>3 Sec</b> (Non-Rotating Only)
2	L	Fast Doubleflash	3.3	
3	M	Tripleflash †	2.5	
4	N	PSU Flicker (Non-Rotating Models)	0.7	<b>3 Sec</b> (Rotating Only)
	A5	CCW Rotation 1 (Rotating Models) †	1.3	
5	O	PSU Random (Non-Rotating Models)	0.6	
	A6	CCW Rotation 2 (Rotating Models)	2.7	
6	F	Quadflash †‡	1	<b>6 Sec</b>
7	G	Quadflash w/Post-Pop †‡	1	
8	H	Singleflash †‡	1	
9	I	Doubleflash †‡	1	
10	J	Variable AKA Delta-Omega	0.3	
11	C	Post pop 1.4CPS †	1.4	
12	E	Random 0.4CPS	0.4	
NA		Steady	NA	<b>9 Sec</b>

† - Approved patterns for SAE J845

‡ - California Title 13

## Troubleshooting



**CAUTION:** High voltages exist in electronic strobe lights. Before attempting service on any strobe light, be sure to disconnect the power for at least five minutes to allow the capacitor to discharge. Failure to heed this warning may result in severe electrical shock and/or injury.

**Please Note:** Most strobe and rotating beacon failures can be traced to wiring and battery problems. Before attempting any service on the circuit itself, please be sure to check all connections and wiring to ensure the correct voltage and/or polarity is reaching your light or remote head.

*If a light on your bar fails to work, please refer to this section to help solve your problem. If you still cannot resolve your problem, please contact our **Customer Service Department** at 585-226-9787.*

The chart below contains some basic guidelines for troubleshooting any problems you may experience with your bar. The section following the chart will explain in further detail how to perform some of the troubleshooting tasks.

<u>Symptom:</u>	<u>Possible Solutions</u>
One rotator spins but won't light up	Check bulb
One rotator does not spin and does not light up	Check the power wire running between the rotator and the terminal block Check the ground wire on the rotator
More than one rotator does not spin and does not light up	Check power to terminal block Check the ground
One single LED light is Out	LED Head needs to be replaced
One LED head does not flash	Check wiring between LED head and flasher unit Check LED head
Multiple LED heads not flashing	Check power to terminal block Check that the bar is properly grounded Check power from terminal block to LED flasher unit Check that the LED flasher unit is grounded properly
One flashing light out	Check bulb Check power wire from flasher unit to bulb Check that the bulb is grounded
Multiple flashing lights out	Check power to terminal block Check that the bar is properly grounded Check power from terminal block to flasher unit Check that the flasher unit is grounded properly
One remote strobe head out	Check the strobe head Check the cable from the remote pack to the strobe head
Multiple strobe heads out	Check power to terminal block Check power to strobe pack Power Outlet (PWR) Check power to strobe pack Control wires (CTRL) Check that the pack is properly grounded Check that the Red w/Green stripe wire IS NOT connected to +12VDC.

**Determining if the bar is properly grounded:**

1. While the bar is turned on, using a test meter, measure the voltage from the base of the bar itself to the negative post of the battery or a good chassis ground if the battery can't be easily reached. You may need to scrape away a bit of anodizing or paint in order to ensure a good connection with the probe of your test meter.
2. If the difference shown is greater than .25 volts, then your ground is not sufficient.
3. If the ground is insufficient, locate the ground wire connection in your lightbar by removing the dome over the section where the wires enter the bar. Please follow the appropriate dome removal instructions listed earlier in this manual when removing this dome. The ground wire is the large (10AWG) black wire attached to the inside of the lightbar base with a ring terminal. Check the integrity of the connection of the ground wire to both the lightbar base and at the other end to a good chassis ground.
4. While inspecting the ground wire connections you should also check that the wire itself is not damaged. Carefully inspect the wire along its entire length, paying special attention to those areas where the wire passes through any holes that may have sharp edges that can damage the wire and the areas where the wire makes any sharp bends.

**Checking the power to the terminal block  
(Determining if the proper voltage is reaching your bar):**

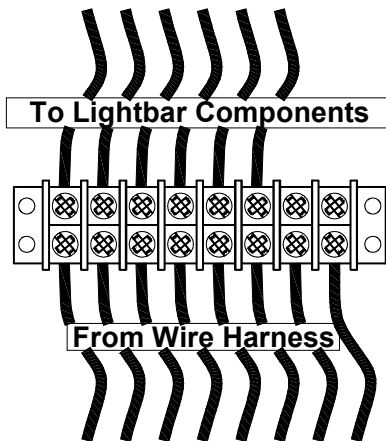

1. Locate the terminal block in your lightbar by removing the dome over the section where the wires enter the bar. Please follow the appropriate dome removal instructions listed earlier in this manual when removing this dome. After entering the bar, the wires will be connected to the terminal block with a number of small Phillips head screws.

2. With the bar turned on, use a test meter to test the voltage at the terminal block. A nominal 12.5 volts should be present. Low voltage can cause erratic flashing in strobe heads or even complete failure of the heads. A minimum of 10.5 volts should be present for the pack to operate properly. Low voltage in strobe lights, flashing lights, or LEDs can result in lowered intensity or even complete failure.
3. Be sure to test each wire that comes into the terminal block for proper voltage.
4. Carefully inspect each wire in the terminal block. Check that the ends of the wires have not frayed and shorted against one another or against the base. This may cause lights to operate inadvertently or may result in the failure of lights.

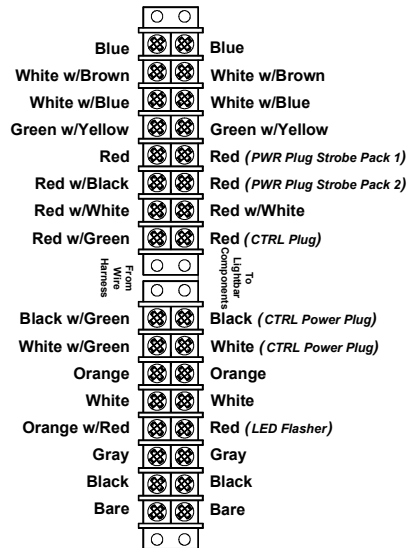

## **TROUBLESHOOTING GUIDE (cont'd)**

### **Checking one non-working strobe or LED head:**

If a problem exists in only one head, a strobe tube or LED head may have burned out, or there may be an open electrical connection in the wiring harness or strobe head.

1. Check connections at and between the strobe pack and the faulty strobe head or between the flasher unit and LED head, including all wiring.
2. Disconnect both the faulty head and a working head.
3. Check the faulty head by connecting it into the side you just unplugged the working head from. If the faulty head still does not work, then the head is bad and will need to be replaced.
4. If the head that was not flashing works when connected to the other side, the problem probably lies in the power pack or flasher unit. Verify this by plugging the other head (the original working head you just unplugged) into the side that previously had the non-working head.

### **Checking multiple non-working strobe heads:**

If the problem exists in only your strobe heads, and none of your strobe heads are flashing, follow these steps to determine the problem:

1. **Check all fuses**, including those at the battery, at the switch panel, in the dash, and on the pack (if applicable). The strobe power supplies all have automotive "blade" type fuses. Remove these fuses, and check them to confirm they have not blown. Replace any blown fuses with only fuses of identical values. Replacing the fuse with the wrong rating may damage your pack and/or vehicle, and will void your warranty.
2. **Check the power and ground wires to your pack.** With the vehicle turned off and while the pack is running, measure the voltage across the red wire (pin 1) and the black wire (pin 2) of the **PWR** connector on the power pack (the one with the Black, Black, and Purple wires). Push the probes of the test meter down into the connector at the wire entry points to contact the terminals for the measurement. A nominal 12.5 volts should be present. Low voltage to the pack can cause erratic flashing or even complete failure of the heads. A minimum of 10.5 volts should be present for the pack to operate properly. If you do not have proper voltage present, your power or ground is bad. Continue to step 3. If your pack is receiving sufficient voltage then skip to step 5.

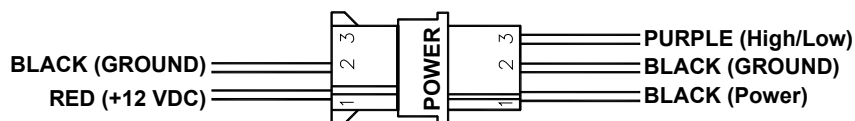

3. **Test the Power to the power supply from the terminal block.** If sufficient voltage is not reaching the pack, and you have already determined that proper voltage is reaching your terminal block, perform the following tests: With the vehicle turned off and while the pack is running, measure the voltage drop in the red wire by taking a reading from pin 1 of your Power connector (Red wire) and the corresponding wire on the terminal block. If this reading exceeds 0.25 volts then there is a poor connection between the terminal block and your power supply in the red wire and it should be checked.
4. **Check the Ground wire on the pack.** If you still have not located the problem, troubleshoot the connections between pin 2 (black wire) of the **PWR** connector on the power pack and the lightbar base, while the lightbar is running. If this reading exceeds 0.25 volts then there is a poor connection between the pack and the lightbar base in the black wire and it should be checked.



### **TROUBLESHOOTING GUIDE (cont'd)**

5. **Check that the proper voltage is reaching the necessary CTRL inputs.** Check that the proper voltage is reaching the Black wire (across from the Black w/Green stripe wire on the Terminal Block) and White wire (across from the White w/Green stripe wire on the Terminal block) of the **CTRL** plug on your strobe pack with the vehicle turned off, and while the bar is running. Measure the voltage across the Black wire (pin 2) on the CTRL plug (**NOT THE POWER PLUG**) and the negative terminal of your battery. Push the probes of the test meter down into the connector at the wire entry points on the pack side of the connectors to contact the terminals for the measurement. Note this reading. A nominal 12.5 volts should be present. A minimum of 10.5 volts should be present for the pack to operate properly. Also, check the voltage on the White wire. If your pack is receiving sufficient voltage to both wires then continue to step 6. If you do not have proper voltage present on either wire, check the wiring to the connector.

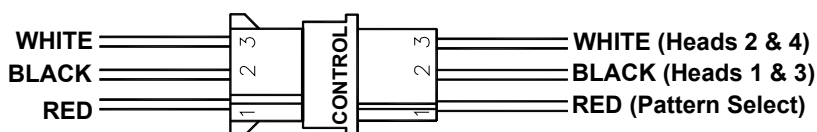

6. **Check the CTRL connector to be sure that +12VDC is not applied the Red wire.** The Red wire on the CTRL connector of the strobe pack is used for pattern select. The patterns are changed by touching AND RELEASING this wire to +12VDC. A constant voltage applied to the Red wire on the CTRL connector will prevent the strobe pack from flashing.
7. **Check each strobe head.** If the leads in one of the heads have shorted out, the output voltage of the other heads may be held down as well. To test for this, unplug all of the heads and plug them in individually, one at a time. If your problem is a result of a shorted head, then the other heads should function properly if the faulty head is no longer connected. Note: A burned out strobe tube does not cause a short and will not affect the operation of the remaining heads. If the problem is not with a shorted head and if proper voltage is reaching the pack, the problem is most likely internal to the pack.
8. If sufficient voltage is not reaching the pack perform the following tests: With the vehicle turned off and while the pack is running, measure the battery voltage *at the battery*. A nominal 12.5 volts should exist. Note this voltage. If this voltage is below 10.0 volts the pack will not function properly and the problem is with the battery. This reading should not be more than 1-1.25 volts higher than the reading in the 4<sup>th</sup> step. If there is an excessive difference then continue on to the next step.
9. With the vehicle not running and the lightbar on, measure the voltage in the red wire by taking a reading from the positive side of the battery to pin 1 of your switch. If this reading exceeds 0.25 volts then there is a poor connection between the switch and the battery in the red wire and it should be checked.
10. If you still have not located the problem, troubleshoot the connections between the good chassis ground and pin 2 (black or blue wire) of the **PWR** connector on the power pack, while the lightbar is running. If this reading exceeds 0.25 volts then there is a poor connection between the switch and the ground in the black wire and it should be checked.
11. This same procedure can be used to check the wires between the terminal block and the pack. Place one probe on the terminal at the terminal block and the other probe into the terminal with the corresponding wire color in the connector on the pack. Once again if any of the readings exceed 0.25 volts then you should check those wires and their connections.

# STARBAR™ Parts List

## Bulbs and Tubes

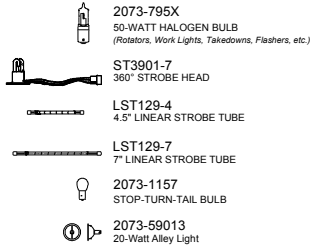

## Mirrors

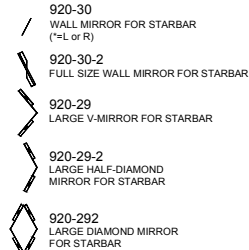

## Domes, Filters, Lenses

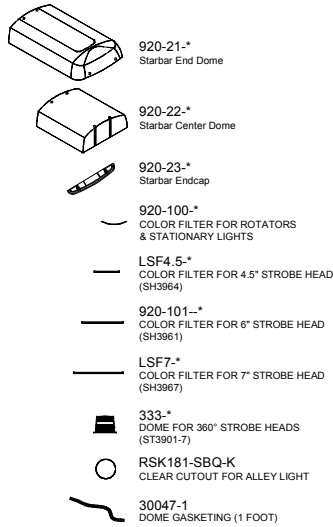

## Interior Components

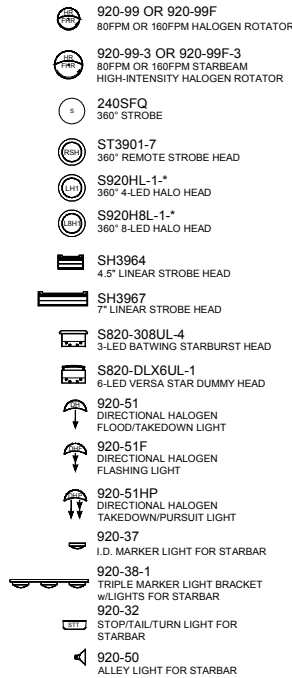

## Screws & Washers

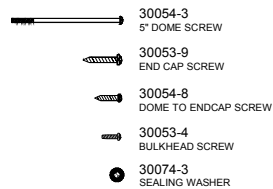

## Power Supplies/Flashers

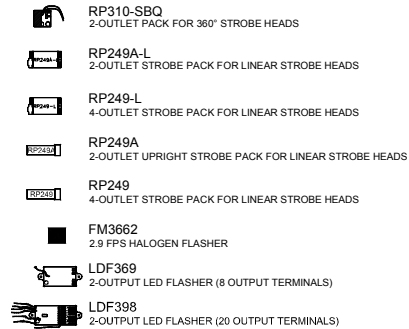

## Mounts

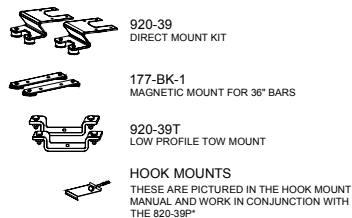

\* = COLOR (White, Black, Clear, or Gray)

## Switches and Switchboxes

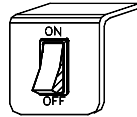

**SP3860-1**

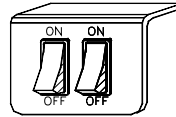

**SP3860-2**

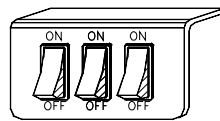

**SP3860-3**

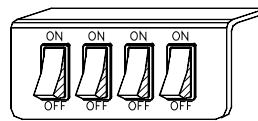

**SP3860-4**

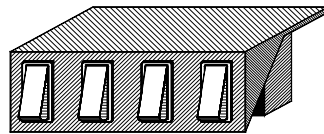

**SP1515**

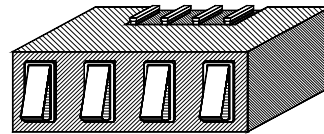

**SB1515**

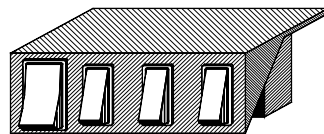

**SP3015**

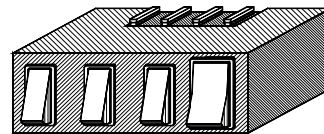

**SB3015**

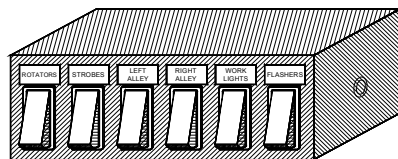

**SB4020**

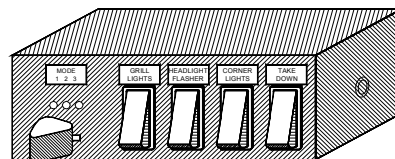

**SB4040**



**STAR LIGHTING PRODUCTS**

CALL US AT 800-392-3552